

TGX 26.440 6x2/2 BLS Midlift Tractor

TGX 26.480 6x2/2 BLS Midlift Tractor

TGX 26.540 6x2/2 BLS Midlift Tractor

Chassis Specification

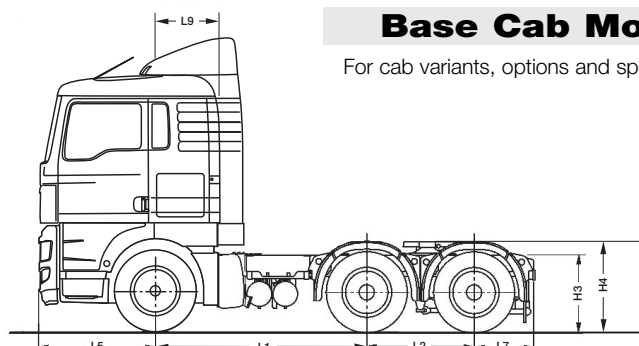

Base Cab Model

TGX 'XL' Cab

For cab variants, options and specifications see separate TGX cab specification sheet

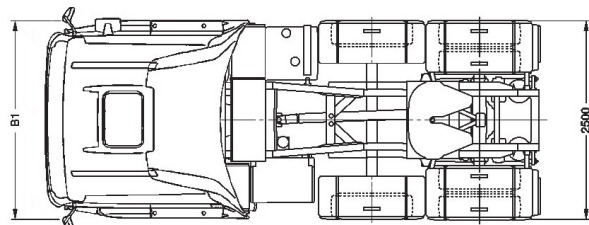

Vehicle Dimensions (mm)

L1	Wheelbase	2600
L2	Rear bogie spread	1350
L5	Front overhang	1475
L7	Rear overhang	800
L9	Centre line front axle to back of cab	805
B1	Width across wings	2490
H3	Frame height at centre rear wheels	- laden 961 - unladen 991
H4	Standard 5th wheel height	- laden 1224 - unladen 1254

Turning Circle

WTW	Wall to Wall	14900
KTK	Kerb to Kerb	13100
	Optimum 5th wheel position for standard specification	935

Unladen Weights (kg +/- 2.5%)

Front axle	5110
Rear axle	3065
Total	8175

N.B. Unladen weights are for vehicle in standard specification with full tank of fuel and without driver.

Plated/Operating Weights (kg)

	Design	UK Legal
GCW Gross Combination Weight	44000	40000 ⁽¹⁾ /44000 ⁽²⁾
GVW Gross Vehicle Weight	26000	23700
Front axle	8000	7500
Midlift axle	7100	7100 ⁽¹⁾ /6500 ⁽²⁾
Drive axle	11500	11500 ⁽¹⁾ /10500 ⁽²⁾

N.B. Tyre changes can effect legal weights. ⁽¹⁾@ 40000 kg or below ⁽²⁾above 40000 kg.

Optional Equipment & Weights (kg)

	Front	Rear	Total		Front	Rear	Total
D26 SCR Engine in lieu of D26 EGR engine (includes AdBlue)	+32	+33	+65	225 Ah Batteries	+30	0	+30
Fixed 5th wheel	+14	-63	-49	385/65R Super Single Tyres on 11.75x22.5 steel rims on front	+38	0	+38
16 Speed manual gearbox	+35	+30	+65	'XLX' Sleeper cab	+40	0	+40
ZF PTO NH/4	+4	+3	+7	'XXL' Sleeper cab	+85	0	+85
Alloy Air Tanks	-4	-11	-15	Lead up ramps	-7	+33	+26
9.00 x 22.5 Alcoa Alloy Wheels	-38	-114	-152	ADR Preparation	+40	0	+40
3 piece steel bumper	+89	-25	+64	All weights indicated above are subject to +/- 2.5% manufacturer's tolerance.			

TGX 26.440 6x2/2 BLS Midlift Tractor TGX 26.480 6x2/2 BLS Midlift Tractor TGX 26.540 6x2/2 BLS Midlift Tractor



Chassis Specification

Engine Model

D26, 6 Cylinder in-line, 12.4 litre (Euro 5)

Features

- Common Rail EDC
- Cruise Control
- Exhaust valve brake
- Road speed limiter set not to exceed 89kph
- On-board diagnostics with NO_x control

D2676 EGR 440PS

440PS @ 1900 rpm
 2100 Nm @ 1000 - 1400 rpm

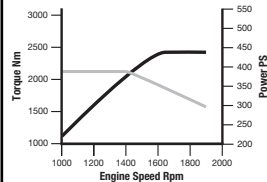

Power

D2676 SCR 480PS

480PS @ 1900 rpm
 2300 Nm @ 1050 - 1400 rpm

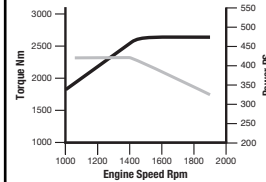

Torque

D2676 SCR 540PS

540PS @ 1900 rpm
 2500 Nm @ 1050 - 1350 rpm

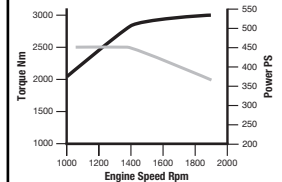

Performance

@44000 kg

Engine Power	Gearbox	Axle Ratio	Geared Road Speed (mph)	Engine RPM @55 mph	Engine RPM @50 mph	Starting Grade	Tyre Size
440PS	12AS2130 DD	2.85:1	77	1360	1235	33%+	315/70R22.5
480PS	12AS2330 DD	2.85:1	77	1360	1235	33%+	315/70R22.5
540PS	12AS2530 OD	3.70:1	76	1375	1250	33%+	315/70R22.5

Clutch

Single plate 430mm diameter, non asbestos

Axles

Steer VOK-09 drop beam
 Midlift Axle LO-08 non steering
 Drive Axle HY-1350 single reduction

Braking System

Type Electronic Brake System (EBS) with Anti-lock Braking System (ABS) and ASR traction control

Features Vented disc brakes, 2 line trailer brake connections and pad wear indicators

Parking Brake Spring brakes on rear axles

Gearbox

MAN Tipmatic 12 speed automated gearbox

Ratios

Forward

1	15.86	2	12.33	3	9.57
4	7.44	5	5.87	6	4.57
7	3.47	8	2.70	9	2.10
10	1.63	11	1.29	12	1.00

Reverse

14.68

Suspension

Steer Axle Parabolic Springs
 Hydraulic Dampers
 Stabiliser

Midlift Axle 2 Bag Air
 Hydraulic Dampers
 Air Operated Lift

Drive Axle ECAS Controlled
 4 Bag Air
 Hydraulic Dampers
 Stabiliser

Steering Gear

Type ZF 8098 Servocom hydraulically assisted.

Manual Gearbox Options

16 speed gearbox, with range change and splitter.

Frame

Construction Bolted and Riveted
 Material High tensile steel
 Section 270 x 85 x 8mm
 940 - 762mm waisted

Wheels & Tyres

Steer Axle Tyres 315/70R 22.5
 steer tread
 Wheels 9.00x22.5

Midlift Axle Tyres 315/70R 22.5
 steer tread
 Wheels 9.00x22.5

Drive Axle Tyres 315/70R 22.5
 drive tread
 Wheels 9.00x22.5

Exhaust System

Ground discharge silencer.

General Equipment

Adjustable roof blade air management with cab side deflectors

Sliding fifth wheel

3 piece plastic rear wings and spray reduction mats

Catwalk

Hoses and couplings including ABS lead

Coupling lamp

Rear axle diff lock

35 litre AdBlue tank (SCR models only)

Remote control central locking

Heated Separ water trap

Telemetry interface module

Fuel Tank

Capacity 450 Litre
 Section Rectangular Aluminium with Integral Step
 RHS mounted
 Locking cap

Electrical System

Type MANTronic CAN bus system with central on board computer and vehicle management computer

Voltage 24v
 Alternator 120 Amp
 Batteries 2 x 12v 175Ah

TGX 26.440 6x2/2 BLS Midlift Tractor
TGX 26.480 6x2/2 BLS Midlift Tractor
TGX 26.540 6x2/2 BLS Midlift Tractor
Cab Options

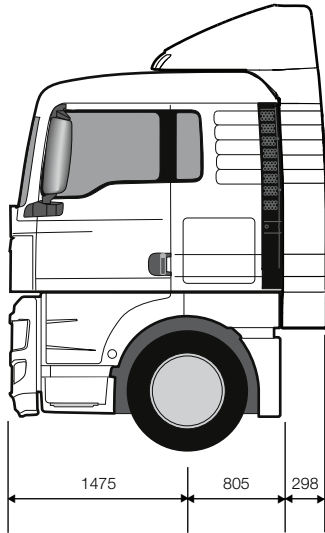

'XL' Sleeper - Standard
Additional weight: 0 kg

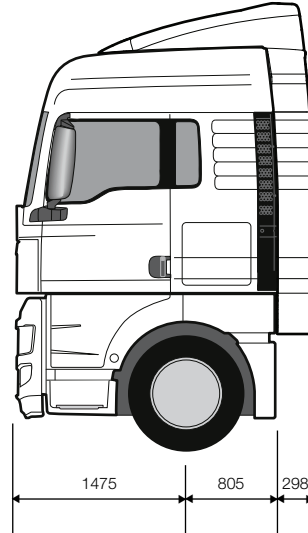

'XLX' Sleeper
Additional Weight: 40 kg

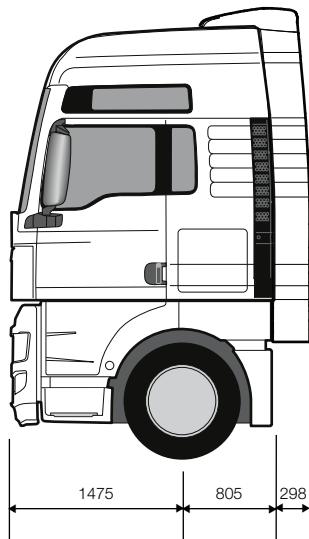

'XXL' Sleeper
Additional Weight: 85 kg

MAN Truck & Bus UK Ltd.,
Frankland Road, Blagrove,
Swindon. Wiltshire SN5 8YU
www.mantruckandbus.co.uk

